

# FreeRider<sup>®</sup>

*working together*

ATTENTION  
READ ALL PARTS IN THIS  
MANUAL BEFORE OPERATING  
YOUR SCOOTER



510GDX

# USER'S INSTRUCTION MANUAL



## SAFETY GUIDELINES

**Warning!** An authorised dealer or certified technician must perform the initial setup of this scooter and must perform all of the procedures in this manual.

The symbols below are used throughout this user's instruction manual and on the scooter to identify warnings and important information. It is very important for you to read them and understand them completely before using the scooter.



**Warning!** Indicates a potentially hazardous condition/situation. Failure to follow designated procedures can cause either personal injury, component damage, or malfunction. On the product, this icon is represented as a red triangle with red exclamation mark.



**Caution!** Indicates situations where extra caution should be taken. These actions should not be performed at any time or in any circumstances. These actions can cause personal injury and/or equipment damage. On the product, this icon is represented as a triangle with red border.

**Please fill out the following information for quick reference:**

Freerider dealer: _____
Address: _____
Phone Number: _____
Purchase Date: _____ Serial Number: _____

*Note: This user's instruction manual is compiled from the latest specifications and product information available at the time of publication. We reserve the right to make changes as they become necessary. Any changes to our products may cause slight variations between the illustrations and explanations in this manual and the product you have purchased. The latest/current version of this manual is available on our website.*



## FOREWORD

Please read and follow all instructions in this User's Instruction Manual before attempting to operate your scooter for the first time. If there is anything in this manual that you do not understand, or if you require additional assistance for setting it up, contact your nearest authorised dealer.

Using your product safely depends upon your diligence in following the warnings, cautions and instructions in this manual.

A full technical specification can be found at the rear of this manual.

Using your scooter safely also depends upon your good judgment and common sense, as well as that of your dealer, caregiver or health professional.



## CONTENTS

Introduction .....	3
Purpose of your scooter .....	3
Rules for safe use .....	4
Getting to know your scooter .....	6
Comfort adjustments .....	7
Operating your scooter .....	9
Freewheeling your scooter .....	11
Safety instructions & warning .....	12
Safety warning & instruction labels .....	17
Learning to get about .....	18
Care & Maintenance .....	20
Batteries & battery charging .....	22
Basic fault finding .....	23
Technical specification .....	26
Classification .....	31
Optional accessories .....	32
Guarantee terms .....	33
Service history .....	34



## INTRODUCTION

Congratulations on the purchase of your scooter. Please read this User's Instruction Manual carefully before you attempt to operate your scooter. Your User's Instruction Manual will assist you to get the most from your machine.

This manual contains important information regarding the safe operation and maintenance of your scooter.

If you have any queries concerning operation or maintenance, consult your authorized dealer.

Please keep in mind that the operator of the scooter is responsible for hazards occurring to other people or their property.

Your scooter has numerous features not found on other power scooters. With proper care and maintenance, you will enjoy many years of dependable service.

Please remember that when it comes to service and repairs, your authorized dealer knows your scooter best.



## PURPOSE OF YOUR SCOOTER

The scooter provides transportation for an elderly or disabled person. It can be used in a variety of indoor and outdoor settings.

The intended user should possess some degree of ability with the use of both arms and hands, reasonable balance and good eyesight, and a degree of spatial awareness.

The user should have received training in the use of the product, preferably in their normal environment.

Your scooter should not be used in torrential rain or deep snow, on loose slippery surfaces and slopes or on wet grass etc., which could become a danger to the rider, or other road users.

**DO NOT** drive your scooter if you are under the influence of alcohol, drugs or medication that may affect your ability. If you are in doubt, consult your doctor.



## RULE FOR SAFE USE

These symbols below are used in this User's Instruction manual to identify warnings and cautions. It is very important for you to read and understand them.



**Warning:** Failure to note the warnings in this users manual may result in personal injury.



**Caution:** Failure to observe the cautions in this users manual may result in damage to your scooter.

Your scooter is a powerful machine, Please read all of the instructions in this manual before operating your scooter. Follow notes carefully to ensure safety at all times.

**ALWAYS** make certain your machine is fully charged and in full working order before starting your journey.

1. **DO NOT** ride your scooter without reading this instruction manual. Also read all of the safety instructions and warning at the start of this manual.
2. **ONLY** drive your scooter if your health condition will allow you to be safe.
3. **DO NOT** exceed the maximum safe gradient outlined for your vehicle.
4. **DO NOT** carry passengers or exceed the maximum carrying weight.
5. **DO NOT** reverse your scooter onto uneven inclines or surfaces. Be cautious when traversing slopes.
6. **DO NOT** drive your scooter in a confined space unless the speed adjustment dial is set low.
7. **DO NOT** turn suddenly at full speed, especially on uneven or sloping ground.
8. **DO NOT** drive your scooter where you cannot safely or legally walk.
9. **DO NOT** drive your scooter unless the seat is locked into the driving position.
10. **DO NOT** drive your scooter over deep, soft terrain (eg. soft earth, deep grass, loose gravel, snow).
11. **DO NOT** drive when under the influence of alcohol or certain drugs which may impair your safety.
12. **DO NOT** climb or descend curbs that exceed the maximum dimension detailed under technical specification of this manual. **DO NOT** turn when negotiating curbs.
13. **ALWAYS** approach obstacles at low speed.
14. **ALWAYS** approach obstacles straight.

15. **ALWAYS** keep your feet on the vehicle when driving.
16. **ALWAYS** proceed carefully while riding, especially as you approach the downgrade of a ramp.
17. **ALWAYS** reduce speed when descending inclines.
18. **ALWAYS** avoid uneven surfaces.
19. **ALWAYS** consult your physician or a therapist if in doubt about your ability to operate a scooter.
20. Transport - **DO NOT** sit on your scooter while it is in a moving vehicle. **ALWAYS** strap down your scooter then transfer to the vehicle seat.
21. The batteries fitted to your scooter are maintenance free and **DO NOT** require topping up with distilled water.
22. **DO NOT** drive your scooter through deep water or clean with a high pressure hose.
23. **DO NOT** drive your scooter through sea sand or sea water, this is very corrosive.
24. **ALWAYS** wash salt splashing from the metal parts of your scooter with hot soapy water as soon as possible.
25. **DO NOT** drive on motorways, highways (i.e. those with a speed limit of over 50mph), cycle lanes or in bus lanes.
26. **ALWAYS** switch your lights on at night or in poor visibility. Wear reflective clothing.

If unintended movement or brake release occurs, turn the scooter OFF as soon as it is safe.

Report all incidents of unintended movement or brake release to the scooter local dealer, and note whether there is a source of EMI nearby.

**Please remember you are a motorized pedestrian and must observe all rules and regulations of other pedestrians wherever possible. Your scooter has been designed for use on most roads. However, you still must drive it with care and attention. Please read the "*Safety instructions and warning*" section of this manual.**

**Please have a safe journey**



## GETTING TO KNOW YOUR SCOOTER

- 1 Steering handlebar
- 2 Driving mirror
- 3 Console
- 4 Charging socket
- 5 Basket
- 6 Front light
- 7 Direction indicator lights
- 8 Front bumper
- 9 Amber side reflectors
- 10 Floor mat
- 11 Alloy wheels with black tyres
- 12 Rear lights and indicators
- 13 Adjustable angle seat with backrest



The scooter supplied has fitted as standard the following features:

- Rear-wheel drive via sealed drive axle.
- 75A/H sealed non-maintenance lead-acid batteries.
- Captain-style seat with folding backrest, adjustable width arm-rests and safety belt.
- Seat rotates and is fully adjustable forwards and backwards and for height.
- Multi-positional handle bars for greater comfort, twin driving mirrors.
- Simple controls situated on the steering handlebars regulate speed and braking.
- Three independent braking systems.
- Steering is controlled by a handlebar attached to a linkage system containing front wheels.
- "State-of-the-art" micro-controller electronics ensures a smooth, comfortable and safe drive on all surfaces and gradients.
- 4/8 m.p.h speed switch selection.
- Automatically charging system.
- Front and rear suspension via sprung hydraulic shock absorbers.
- Front and rear lights. Direction indicator warning lights.
- Rigid steel tubular frame.
- Your scooter can be removed; with the handlebars lowered and with the aid of ramps your scooter can be transported in a suitable estate car. However your scooter is not designed to transport the user in a moving vehicle.

Your scooter should be serviced as recommended in this manual by an approved local dealer in order to ensure safe, reliable operation. For service details and list of consumable parts, options and accessories refer to the appropriate section of this manual.



## COMFORT ADJUSTMENTS

Before setting out on your scooter, you need to make sure that your seat is in the correct driving position. Your local dealer will set the seat to the correct height for your individual needs.

The seat has seven basic adjustments to assist your comfort.

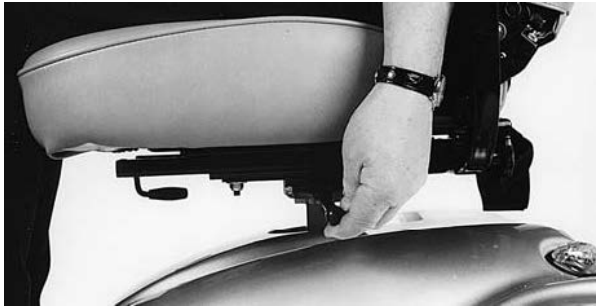

### 1. Seat Lock Lever:

This allows the seat to swivel through 360 and lock in a convenient position. The locking lever is located under the left side of the seat. It can be re-located on the right side for your convenience. Pull up fully to release the seat allowing rotation. Release level to lock the seat into the desired position.



**Warning:** When driving, the seat should be locked in the straight ahead position.



**Caution:** The seat locking level must lock be lifted up fully when rotating the seat, failure to observe this may result in unnecessary wear of the seat post.

### Removing seat from scooter:

The seat mounting post is designed with a special "**one position**" lifting point, this will prevent the seat from inadvertently dismounting itself in the case of an accidental upset of the scooter. The seat can be demounted by turning the seat 90° to right or left from the forward driving position.

### 2. Armrest Width Adjustment:

On each side at the rear of the seat you will find a large black knob. By simply loosening this knob you are able to slide the armrests in or out to whatever width you desire. Re-tighten the knobs fully. You may need a friend to assist you with this initial setting up operation. This may extend the width of your scooter.

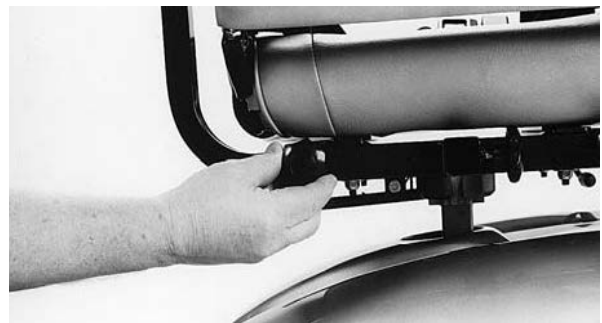

**Caution:** The backrest of your seat will not fully fold forwards if armrests are positioned too closely towards one another.



**Warning:** **DO NOT** drive your scooter with the arms removed or in the raised position.





### 3. Armrest Angle Adjustment:

The armrest angle can be adjusted individually to suit your needs. To make adjustments to the armrest angle you will need two 13mm spanners (not provided). Lift the arm upwards, you will find the adjusting bolt. First loosen the locking nut, rotate the bolt in or out until the required angle is found, lower the arm and check the angle for comfort; re-adjust as necessary. Finally tighten the locking nut.



**Warning:** When lowering the arm make certain clothing or fingers are not positioned under it.

### 4. Seat Slide Adjustment:

Located on the right front side of the seat. This lever allows you to adjust your seat forwards and backwards when sitting on the seat. Simply pull up the lever and move in the desired position backwards by pushing or forward by hitching. As soon as the lever is released, the seat will lock into the new position.



**Warning: DO NOT** carry out this operation when your scooter is moving, first stop apply the brakes and then carry out the seat positioning.



**Caution:** Test that the seat has fully locked by hitching backwards and forwards.

The seat as fitted to your scooter, has a fold down backrest. The seat has four height positions. Your local dealer will position the seat to allow you the most comfortable driving position.



### 5. Seat Height Adjustment:

You may need to alter the seat height setting at a later date, please follow these instructions.

(1) Remove your seat from the scooter by lifting the seat locking lever and lifting the seat clear of the vehicle.

*Note: Your seat can only for safety reasons be removed when it is turned 90° to the right from the straight ahead driving position. Please take care when lifting heavy weights. Place your seat on a soft clean work area.*

(2) With the aid of a 17mm spanner (not supplied) loosen the 10mm seat clamp fixing bolt.

(3) Remove the 10mm fixing bolt and reposition the bolt into one of the four preferred location holes of the seat mounting tube.



**Warning:** The seat post fitted to your scooter is universal for a number of model scooters, **DO NOT** use the top

hole in the seatpost, this will allow the seat to mount too close to the plastic bodywork and may damage it.

(4) Re-tighten the 10mm fixing bolt. Refit the seat onto your scooter.



**Warning:** **DO NOT** have the seat set too high, you must be able to place both feet firmly on the scooter's floor area. Stability will be reduced the higher your seat is set on the mounting tube. **ALWAYS** take great care when cornering, lean into the corner to achieve the best stability from your scooter.



#### 6. Backrest Angle Adjustment:

The angle of your backrest can be adjusted to a comfortable driving position by adjusting two stop bolts. To make the adjustment you will require two 13mm spanners (not provided). Push the backrest forwards, you will note the adjustment bolts situated one either side of the rear of the seat.

First loosen the upper locking nut, rotate the bolt in or out until the required angle is found, push the backrest fully backwards and check the angle for comfort, re-adjust as necessary. Adjust the opposite stop bolt until it makes contact with the backrest. Finally tighten the two locknuts.



**Warning:** Both stop bolts must make contact with the two stop brackets situated on the lower part of the backrest, failure to observe this warning may distort the backrest frame.



**Warning:** The rearward stability of your scooter will be reduced the greater the backrest angle is set past 90°. **ALWAYS** take great care when going up steep slopes or kerbs, **ALWAYS** lean forwards to achieve the best stability for your scooter.

#### 7. Backrest Height Adjustment:

The upper cushion of your backrest can be adjusted for height, giving you more back support if you are tall, by operating the small latch at the base of the left hand round support bar. Lift the cushion up or push down for the most comfortable position. The headrest will also lift out for convenience.



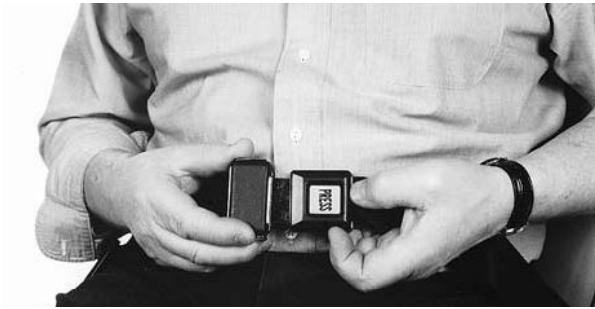

### 8. Lap Safety Belt:

Your seat is fitted with a safety belt to prevent you from slipping forwards under braking conditions or when going down a slope or over obstacles, always use it-even for short journeys.

The lap belt can be adjusted on one side to fit comfortably around your waist. To fit simply connect the two buckles together until

a distinct "click" is heard. To remove simply "press" the red buckle and the two belts will separate.



**Caution:** Care should be taken when the belt is not in use, it should be connected together and placed in the centre of the seat cushion. Failure to observe this notice could lead to the two buckles falling onto and damaging the bodywork, catching a person or foreign body.

### HANDLEBAR ADJUSTMENT

The handlebar of your is designed to allow you to position it in a comfortable driving position. It can be locked into numerous positions or unlocked to move freely for transportation.

The handlebar lock is operated by a black lever positioned on the right hand side of the handlebar. To release the handlebar from a locked position pull the black lever upwards, the handlebar will now move freely, but under mild tension. To lock the handlebar into a comfortable driving position, simply push the black lever downwards until the handlebar is locked firmly into position. With the



combination of the seat adjustment together with the handlebar movement, you should find a suitably comfortable driving position.



**Warning:** ALWAYS make certain the handlebar locking lever is fully down and the handlebar is securely clamped onto the chrome support plates before driving your scooter. For service adjustment of this part, refer to the "**Care and Maintenance**" section of this manual.



## OPERATING YOUR SCOOTER

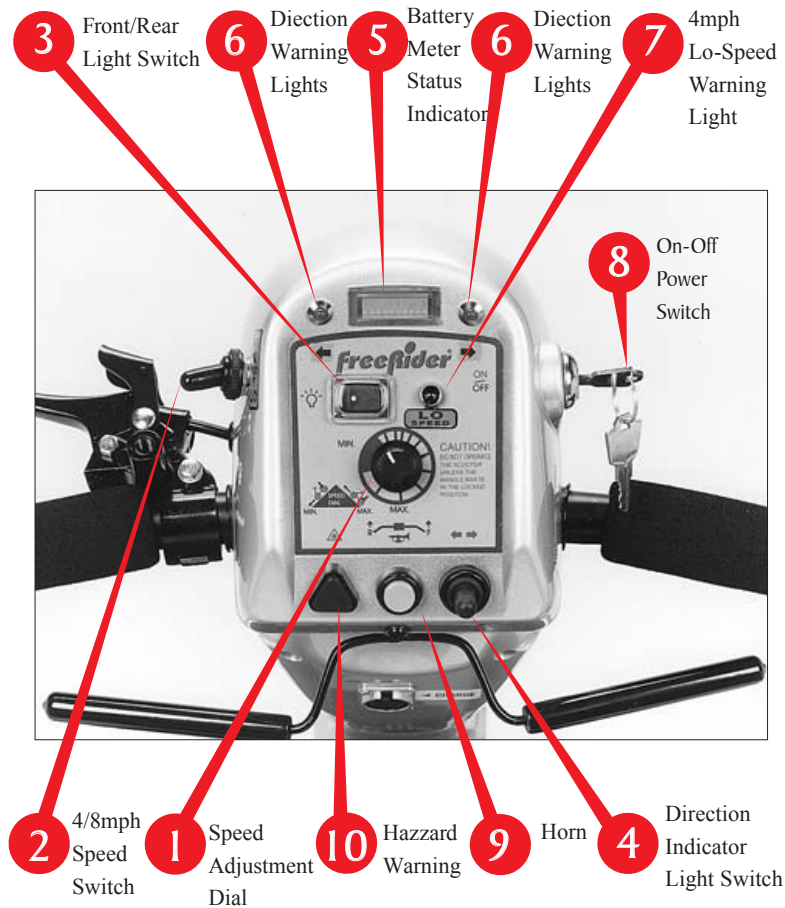

### 1. Control Features:

Your controls are located on the handlebar console:

- (1) **Speed Adjustment Dial:** This allows you to pre-select desired top speed. The dial is proportional to speed and can be set anywhere between "min" and "max" increments. Turn the dial knob anti-clockwise to minimum for a very gentle operation, and clockwise towards maximum to increase your speed.

*Note: When attempting to climb obstacles, you will need to set the dial to a high setting. Remember the higher position you set your speed dial to, the faster your scooter will travel.*



**Caution:** The speed adjustment dial(1) works in conjunction with the 4/8mph speed switch (2), if both are set to their lowest settings there may not be sufficient power delivered to the motor to drive your scooter, in this case turn the speed dial up to a higher setting.

- (2) **4/8mph Hi/Lo speed Switch:** Located on the left side of your console this switch controls the maximum high (Hi) and low (Lo) speed range for your scooter. When riding on the pavement or in shopping areas the low 4mph speed range must be engaged, this is a legal requirement and must be adhered to at all times. When the low speed range is chosen a "red" warning light will illuminate. The Hi/Lo speed range switch can be operated while the scooter is in motion.

Please note the Hi/Lo speed switch works in conjunction with the speed adjustment and the forward/reverse speed lever; the speed dial must be set to it's highest setting for maximum speed in both Hi and Lo speed settings.

- (3) **Front/Rear Light Switch:** This rocker type switch controls the function of the front and rear lights. Simply push down on the left side for 'on' and the right side for "off".
- (4) **Direction Indicator Light Switch:** Located at the bottom right of your console, the direction indicator lights for right and left manoeuvres are controlled by this switch. When making a turning manoeuvre on the road the appropriate switch direction should be made. Simply, when turning right "flick" the switch to the right, you will note a warning "bleeper" is audible and the appropriate direction warning light will flash. To cancel the direction indicator return the switch to the centre position. The left direction indicators are activated by "flicking" the switch to the left.



**Caution:** Please note the direction indicators are not self-cancelling.



**Warning:** Please be aware to test the function of your direction lights before each journey. Failure to observe this warning could put you and other road users into a dangerous situation. If in the event a direction indicator bulb fails, you will note the direction warning light on your console flashing quicker than normal, in this situation the appropriate bulb should be substituted.

- (5) **Batter Status Indicator Light:** Located at the top of your console. This is a 10 bar segmented colour illuminated display which indicates when your scooter is switched on, it also displays the status of the batteries, the speed controller and the scooter's electrical system.
- (6) **Direction Warning Light:** This green light will illuminate when the direction indicator switch is activated to the right for a right turn and to the left for a left turn. The light will also flash at a higher rate than normal to indicate a bulb failure in one of the front or rear direction lights.
- (7) **4m.p.h. Lo Speed Warning Light:** This red light will illuminate when the Hi/Lo speed switch is engaged in the slow speed position, see also point No.2 above -Hi/Lo speed switch.
- (8) **On-Off Power Switch:** Located on the right side of your control console. Insert the key and turn clockwise .This controls the power to your speed control system. You will note that after half a second the battery condition gauge will illuminate with a solid light. Your is now ready to drive. To switch off your scooter turn the key anticlockwise. Remove the key when your scooter is left unattended.



**Caution: DO NOT** switch to "off" when your scooter is moving. Failure to observe this warning will result in the motor brake being applied suddenly and placing you in a dangerous situation.

You should **ONLY** switch "off" when in motion in the case of an emergency. Continual use in this mode may cause undue stress to the drive system and damage the main electronic speed control unit. Be extremely cautious on slopes. Sit upright in your seat or your machine could become less stable.

**Sleep Time:** When you rest your scooter with the electronics switched "on" you are using valuable battery power. Your scooter will automatically go into a sleep mode to preserve battery energy after approximately 15 minutes. To start your scooter again simply switch the key to "off" and back to "on" again, your scooter is now ready to go.

- (9) **Horn Button:** Positioned in the bottom centre of your console, press to sound a warning to other road users.
- (10) **Hazard Warning:** Positioned to the bottom left of your console, when pressed this red triangular button activates all of the amber flashing direction lights to warn other road users that you are stationary or in distress. This function should only be used in emergencies. You will not that both green direction lights at the top of your console are flashing to warn you the hazard system is in operation. To cancel the hazard warning simply press and release the red triangular button.

## 2. FORWARD-REVERSE SPEED AND BRAKING LEVER:

Located under the handlebar grips. Your speed and braking in forward and reverse motion is controlled here. The right lever moves your scooter in a forwards direction and also controls the rate of speed by the proportional amount of pressure applied. The left lever moves the in a reverse direction and controls the rate of speed by the pressure applied. The lever when released will automatically return itself to the neutral braking position, and you will slow down and gently stop. The rate at which you brake is also proportional to the movement of the control lever, the quicker you return it to the centre position the harder you will brake. Your Freerider distributor can modify your scooter if you require so that the left hand lever will give you forward speed direction and the right hand lever will give you reverse speed direction.





**Warning: DO NOT** attempt to operate the right and left lever simultaneously, failure to observe this warning may distort the lever system and could put you at risk. It should also be noted that reverse speed is set at half of full speed, this is a safety precaution, always make certain the Hi/Lo speed switch and the "min and max" speed selection dial are set high enough to give you adequate power for your reverse manoeuvre.



**Warning:** If you are not an accomplished outdoors powered vehicle driver, we strongly recommend that you seek advice from your local 'road safety officer' who may be able to advise you of any training schemes that are available in your locality, your local dealer may also help you in finding training in road craft skills.

We strongly recommend that you first practice in an open, safe area, free from traffic, preferably with a companion who can assist you. Please remember as a road user you are required by law to drive your scooter with due care and regard to other road users and pedestrians. Although you do not by law require a driving licence, road tax, M.O.T. Test or insurance, we strongly recommend that you insure yourself and your scooter against any risk that could occur, your local dealer will advise you of insurance companies who specialise in this field or you could seek advice from your own insurance company who provide other cover for you such as house insurance.



**Warning: DO NOT** attempt to drive your scooter until you have read and understood all of the details in this users instruction manual, failure to observe this manual may place you in a dangerous situation.

### 3. MANUAL EMERGENCY BRAKE:

Located on the left side of the steering handlebars. The lever when pulled towards you operates two front drum brakes. This manual braking system works independently of the main electronic braking system and must only be used in an emergency situation, for instance if the drive transmission becomes disconnected for reasons of convenience to push you scooter.



To operate the manual brake simply squeeze the lever towards the handlebars, the harder you squeeze the more pressure will be applied to the brakes.

The brake lever for convenience can be locked in the "brake applied" position. To permanently lock the lever on, simply apply the brake and

flick down the "locking latch" which is situated at the pivot end of the manual brake lever. To release the lever simply squeeze the "manual brake lever" and the locking latch will automatically release.



**Warning: DO NOT** drive your scooter with the manual brake applied. Failure to observe this warning will overload your scooter's drive motor and drain your batteries of power, this action could result in permanent damage to the motor, batteries and brake components.



## FREEWHEELING YOUR SCOOTER

If for the reasons of convenience, you require to push your scooter for a short distance, the drive system can be put into "freewheel mode". This will allow your scooter to roll freely.

### 1. Freewheel Procedure:

The freewheel device is a red lever located at the rear right hand side of your scooter. To freewheel your first switch off the power switch located on the control console. Pull up the black lever until a distinct click is felt. You can now push your with ease. Please note, in this mode with the power switch in the off position, the braking safety system is automatically activated when the scooter is pushed quicker than walking speed, this is an automatic "run away" safety checking system, it also reduces the risk of casual theft.

By switching on the console power switch at this stage you will introduce some heavy motor braking, you will note that nine bars on the console battery gauge are flashing. This indicates that your is in a freewheel mode and you cannot drive your scooter. Note, the quicker you push your scooter the heavier the brake will be applied.

To re-engage the drive system, simply push down the brake until a distinct click is felt, switch the power switch on your console off and then on, the battery gauge light will be fully illuminated and you will be able to drive your scooter once again.



**Warning: DO NOT** sit on your scooter with the freewheel device in the disengage position. Your scooter will not drive in this mode , the bar status light on your console will flash nine bars.



**Warning:** If your scooter is in the freewheel mode when you turn on your power key switch and depress your speed forward-reverse lever, you will not be able to move under motor power, Dismount and re-engage the drive system by pushing the red freewheel lever down.



Remount your scooter, switch the power switch off and on again until the battery gauge fully illuminates, your scooter will now drive under motor power again.



**Warning: ALWAYS** check that the freewheel device is in the drive position before attempting to drive your scooter after it has been left unattended for a period of time.

Failure to observe this warning may result in an accident.

*General Note: If you are able to push your scooter the drive system is disconnected. **DO NOT** attempt to drive your scooter. Please check once again the afore mentioned procedure for re-engaging the drive.*



**Warning:** If your batteries are disconnected from your scooter there will be no brake function in the freewheel mode. **DO NOT** leave your scooter unattended in this situation as it could roll away causing damage to other parties or property. **ALWAYS** re-engage the drive system when left unattended.







## SAFETY INSTRUCTIONS & WARNING



**Warning: DO NOT** attempt to operate your new scooter for the first time without completely reading and understanding all of the facts in this User's Instruction Manual.

Your scooter is a state-of-the-art device designed to enhance and increase your mobility. Dealer provides a range of scooters to best suit the individual needs and circumstance of the scooter user.

Please be aware that the final selection and purchasing decision regarding the model of scooter to be used is the responsibility of the scooter user who is capable of making such a decision with assistance from his/her healthcare professional (i.e. medical doctor, physical therapist etc.)

The contents of this User's Instruction Manual are based on the expectation that the mobility device expert has properly fitted the scooter to the user and has assisted the prescribing healthcare professional and/or the authorized measures that will help you to become accustomed to the safe operation of your scooter.

There are certain situations, including some medical conditions, where the scooter user will need to practice operating the in the presence of a trained attendant. A trained attendant can be defined as a family member or care professional specially trained in assisting a scooter user in various daily living activities also seek advice from your local Road Safety Officer and disability groups.

When you begin to use your scooter, you will probably encounter situations in which you will need some practice. Simply take your time and you will soon become confident and in control as you manoeuvre through doorways, on and off elevators, up and down ramps and over moderate terrain. Below are some tips, precautions and other safety measures that will help you to become accustomed to the safe operation of your scooter.

### SAFETY CHECK

Get to know the feel of your scooter and it's capabilities. The dealer recommends that you perform a safety check before each use to make certain your scooter operates smoothly and safely. For details on how to perform these necessary inspections, see the "**Care and Maintenance**" section of this manual. Perform the following inspection prior to using your scooter.

- Check tyre inflation, Rear tyres maintained at 35 p.s.i.(2.5 bar); Front tyres maintained at 30 p.s.i.(2.1bar).
- Check all battery connections, making certain they are tight and not corroded.
- Check batteries have been fully charged.
- Check operation of brakes.
- Check operation of all lights.



**Warning:** It is critical that the pressure in the pneumatic tyres is maintained at all times. Failure to observe this warning may result in a serious failure of the tyre or wheel, causing serious personal injury and/or damage to your scooter

## SOLID TYRE INSERTS (PUNCTURE PROOFING)

Your scooter is fitted with pneumatic tyres(air) as standard equipment, the pneumatic quality and feel of these tyres greatly enhances the ride quality of your scooter. We **DO NOT** recommend the fitting of solid inserts to replace the air pressure in your wheels, these products add unnecessary weight and place more stress on the suspension components of your scooter. If puncture resisting security is desired then use an appropriate liquid sealer, your local dealer can advise you on these systems.



**Warning: DO NOT** carry passengers on your scooter. Your Scooter is designed for a single occupant which complies with legal requirements for pavement vehicles. Carrying passengers on your scooter may result in personal injury and/or property damage.

## WEIGHT LIMIT

Your scooter is rated for a maximum 155kg (342lbs) weight limit.



**Warning:** Exceeding the weight limit will void your warranty and may result in personal injury and damage to your scooter.

The dealer will not be held responsible for injuries and/or property damage resulting from failure to observe these weight limitations. Please also remember when carrying heavy objects that this will increase your weight and may make your scooter unstable.

## CORNERING

Excessively high cornering speeds can create the possibility of tipping. Factors which affect the possibility of tipping include, but are not limited to, cornering speed, steering angle (how sharply you are turning), uneven surfaces, inclined surfaces (such as heavily cambered pavements), riding from an area of low traction to an area of high traction (such as passing from grass areas to a paved area - especially at high speed while turning), and abrupt directional changes. **DO NOT** corner at high speed! If you feel that you may tip over in a corner, reduce your speed and steering angle to prevent your scooter from tipping.



**Warning:** When cornering sharply, reduce your speed. When using your at higher speeds, anticipate changes in the road surface. This will greatly reduce the possibility of a tip or fall. To avoid personal injury or property damage, **ALWAYS** exercise common sense when cornering.

It is **ALWAYS** advisable when cornering to lean towards the corner, just as you would on a bicycle, this will enhance the sideways stability of your scooter.

## BRAKING

Your scooter is equipped with two powerful electronic brake systems, and an emergency manual system:

1. Regenerative: Uses the electricity generated in your scooter drive motor to rapidly slow your scooter when the speed direction lever is returned to the centre (neutral drive) stop position.
2. Disc Park Brake: Located on the end of your drive motor, it activates mechanically after the regenerative brake slows your scooter to a near stop, or when power is removed from the drive system for any reasons, as in the case of switching your machine off.

3. Mechanical (Emergency) Brake: Two drum brakes positioned on the front wheels can be activated by the lever positioned to the left hand side of the handlebars. The brakes are operated by squeezing the lever for emergency braking, as in the unlikely event of transmission failure.

Brake engagement is far more abrupt at higher speeds. It is important that you anticipate when the brakes will engage and that you are braced for the resulting deceleration. Practice braking on level ground to understand your braking distance time.



**Warning:** Your scooter can decelerate very quickly. **DO NOT** decelerate or turn abruptly when travelling at high speed unless absolutely necessary. If it is necessary to decelerate or turn abruptly when driving at high speed, brace yourself by gripping the steering handlebar tightly and positioning your feet firmly on the floorboard. Users who cannot grip the handlebar tightly and/or place their feet firmly against the footboard should avoid deceleration from or turning abruptly at high speed, and therefore should avoid travelling at high speed. Failure to observe this warning could result in serious personal injury and property damage. **ALWAYS** brace yourself firmly when decelerating your scooter.

Never drive down slopes at full speed, **ALWAYS** adjust your speed to the driving condition and allow for gradual descents on inclines.

*Note: when descending a slope it is good practice to switch your scooter into the Lo (4mph) speed range, this can be activated while you are driving.*

## OUTDOOR DRIVING SURFACES

Your scooter is designed to provide optimum stability under normal driving conditions i.e. dry, level surfaces composed of concrete or asphalt. However, the dealer recognizes that there will be times when you will encounter other surfaces such as packed soil, grass and gravel. These surfaces may not be sound and fail to give good traction, caution should be considered before driving on this type of surface to prevent stability problems resulting in injury or damage to your scooter.

- Reduce your scooters speed to the "Lo" switch position when driving on uneven terrain or soft surfaces.
- Avoid long and unsafe grass that can become tangles in the running gear or may hide debris and holes.
- Avoid loosely packed sand and gravel.
- If you feel unsure about a driving surface, please anticipate and avoid that surface.
- **ALWAYS** avoid kerbs if possible use "cut-outs" in pavements.

## STREET AND ROADWAY DRIVING



**Warning:** Your scooter has not been designed for operation on public streets and roads. It is designed for operation on pedestrian pavements and traffic free shopping areas.

Your scooter must be driven with due care and compliance with the Road Traffic Acts and conditions of the Highway Code. **ALWAYS** obey all local pedestrian traffic rules. Wait until your path is clear of traffic, and then proceed with extreme caution.

Note: **ALWAYS** wear light or illuminating clothing when driving your scooter.

Be aware that it may be difficult for traffic to see you when you are seated on your scooter. Only drive your scooter on the pavement at the "Lo" 4mph (6km) speed range, it is illegal to drive your over 4mph in areas where pedestrians walk, i.e. shopping areas, crossings, under passes, parks etc.

## WARNING BEACON

A warning beacon must be fitted and illuminated if you drive on an unrestricted dual carriageway i.e. a carriageway that allows speeds of over 50mph. We **DO NOT** recommend that you drive on these roads and advise you to choose an alternative route, avoid fast moving traffic at all times.

## INSURANCE

Although it is not a legal requirement for accident insurance cover (third party), it is a sensible precaution. Your local dealer will be able to give you details of specialist insurance companies or your own insurance company will be able to advise you.

## WEATHER PRECAUTIONS



**Warning:** The dealer recommends that you **DO NOT** operate your scooter in icy or slippery conditions or on salted surfaces i.e. roads and pavements etc. Such use may result in accident, personal injury or adversely affect the performance and safety of your scooter.



**Warning:** The dealer recommends that you **DO NOT** expose your scooter to any type of heavy moisture at any time i.e. rain, snow or power washer. Such exposure can damage your scooter. Never drive through deep water or expose your scooter to sea water.

Note: salt is very corrosive to metal and electronic components. Following use in winter or exposure to sea sand and water, your scooter should be washed with a mild soap and water to remove all ingress of salts. **DO NOT** use a power hose. **DO NOT** operate your scooter if it has been exposed to moisture until has been thoroughly dried out.



**Warning:** If your scooter is fitted with a canopy (cab) avoid gale force winds i.e. winds above 61km/h (38mph), avoid exposed areas near to water.

## FREEWHEEL YOUR WESTMINSTER

Your scooter is equipped with a manual freewheel device for convenience when you need to push it.



**Warning: DO NOT** use your scooter in the freewheel mode without an attendant present. Personal injury may result.



**Warning: DO NOT** attempt to personally place your scooter in freewheel mode while seated on it. Personal injury may result. Ask an attendant for assistance if necessary.



**Warning: DO NOT** place your scooter in freewheel mode while on an incline. The scooter could roll uncontrollably on its own, causing personal injury.

## TYRE INFLATION

If your scooter is equipped with pneumatic tyres, you should check their condition on a daily basis. Have the tyre pressure checked and if necessary inflated to the recommended pressure at least once a week. Properly inflated tyres will help ensure a smooth, stable ride with minimum rolling resistance for your motor, it will also prolong the tyre's life and resistance to punctures.



**Warning:** ALWAYS inflate your tyres from a regulated air source. Over inflation from an unregulated air source could over inflate your tyres resulting in "blow out" or personal injury. DO NOT over inflate your tyres to the maximum inflation pressure indicated on the tyre cover, failure to observe this warning could damage your scooter wheels. Your tyres are designed for low speed use on pavements and roads. They are not for high speeds, such as in vehicles designed to travel at speeds in excess of 15 mph.

## MOTOR VEHICLE TRANSPORTATION

Currently there are no standards approved for "tie down" systems in a moving vehicle of any tyre to transport a person while seated in a scooter. Although your scooter may be equipped with a positioning belt, this is not designed to provide proper restraint during motor vehicle movements. Anyone travelling in a motor vehicle should be properly secured in the motor vehicle seat with a safety belt fastened securely.



**Warning:** DO NOT sit on your scooter while it is in a moving vehicle. Personal injury may result.



**Warning:** ALWAYS make certain that your scooter is properly secured when being transported. Failure to comply may result in personal injury and/or damage to your scooter.

## POSITIONING SAFETY BELT

Your scooter is fitted as standard with a positioning safety "lap" belt. It is a legal requirement for Class 3 vehicle riders to wear this belt.



**Warning:** Wear your seat belt at all times, and make certain it is adjusted and fastened securely. Serious personal injury may result if you fall from your scooter.

## ACCESSING YOUR SCOOTER

Getting on and off your scooter requires a good sense of balance. Please observe the following tips when getting on or off your scooter:

- Make certain your scooter is switched off at the power switch, and the power key is removed.
- Ensure your Westminster is not in the freewheel mode
- Make certain the seat and handlebars are locked firmly into position.
- The seat armrests can be lifted up to make access easier. Make certain you DO NOT attempt to drive with the armrests raised.



**Warning:** Position yourself as far back into the scooter seat as possible to prevent tipping and causing injury.



**Warning:** Avoid using the armrests for weight bearing purposes, such use may cause the scooter to tip and cause personal injury and/or damage to the scooter.



**Warning:** Avoid putting weight onto the steering handlebars, such use may cause the scooter to tip and cause personal injury and/or damage to the scooter.



**Warning:** Avoid putting all of your weight onto the footboard, such use may cause the scooter to tip and cause personal injury.

## MODIFICATIONS

The local dealer has designed your scooter to provide maximum mobility. A range of accessories are available from local dealer, to further customise your scooter needs. However, under no circumstances should you modify, add, remove or disable any feature, part or function of your machine.



**Warning:** Failure to observe this warning may result in personal injury and/or damage to your scooter.

## INCLINES

More and more modern buildings are designed with disability access in mind. Ramps have specified percentage of inclination, designed for easy and safe access. Some ramps may have turning switchbacks (180 degree turns) that require you to have good cornering skills on your scooter.

- Proceed with extreme caution as you approach the downgrade of a ramp or other incline, sit right back in your seat, brace your arms on the handlebars and your feet on the floorboard.
- Take a wide arc with your scooter's front wheels around tight corners, your rear wheels will follow preventing you from cutting the corner short and bumping or getting hung up on raised kerbs.
- When descending an incline keep your speed adjustment set to the slowest speed setting to ensure a safely controlled descent and driving in a forward direction only. If your scooter descent is quicker than you anticipated allow the scooter to completely stop, then progress at a slower speed setting.
- When climbing an incline, try to keep your scooter moving, if you must stop, start up again slowly and then accelerate smoothly with caution. Avoid sudden stop starts, lean forward towards your handlebars to increase stability and prevent rearward tipping.



**Warning:** Never drive down an incline at full speed.



**Warning:** When climbing an incline, **DO NOT** zig-zag or drive at an angle up the face of the incline. Drive your scooter smoothly up the incline without stopping, this greatly reduces the possibility of a tip or fall.



**Warning:** You should not travel over a potentially hazardous incline i.e. areas covered with ice or snow, cut grass or wet leaves or any unstable surface.



**Warning:** DO NOT overload your scooter at the rear when climbing an incline. ALWAYS lean forward to provide the best stability and prevent rearward tipping.



**Warning:** Any attempt to climb or descend an incline steeper than shown in the scooter Specification at the rear of this manual may put your scooter in an unstable position and cause it to tip, resulting in personal injury.

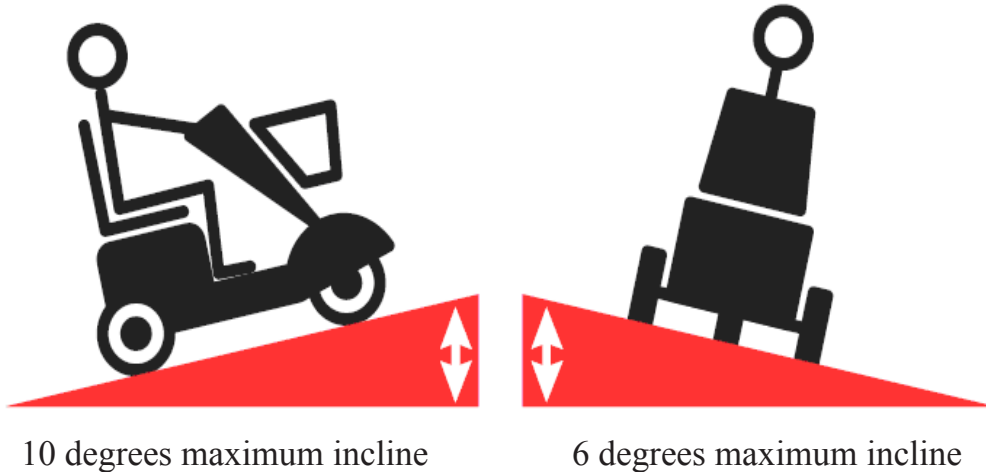

#### STAIRS AND ESCALATORS



**Warning:** Scooters are not designed to travel up or down stairs or escalators. ALWAYS use an elevator. Failure to observe this warning may result in injury to yourself and others and damage your scooter.

#### PREVENTING UNINTENDED MOVEMENT



**Warning:** If you anticipate being seated in a stationary position for an extended period of time turn off the power key switch, this will prevent unexpected motion due to inadvertent movement of the direction control lever. Failure to observe this warning may result in personal injury.

*Note: Your scooter electronics incorporate a "sleep" time mode following fifteen minutes of inactivity your scooter will automatically switch itself off. To start again simply switch your scooter off, then on again.*

#### DISPOSAL OF ELECTRO-MOBILE SCOOTER

In time when your scooter becomes unusable it must be disposed of in accordance with the laws implemented at that time. For further information regarding the recycling arrangements for this type of vehicle and its batteries, contact your local authority or government department, details of this can be found in your telephone directory.

**ALWAYS TAKE CARE AND BE SAFE.**

# SAFETY WARNING & INSTRUCTION LABELS

The following labels are positioned on your scooter; they communicate important warnings or instructions regarding the safe operation of your scooter. Please familiarize yourself with their location.



**WARNING**  
 READ THE OWNERS  
 MANUAL BEFORE  
 OPERATING THIS DEVICE

**CHARGE**

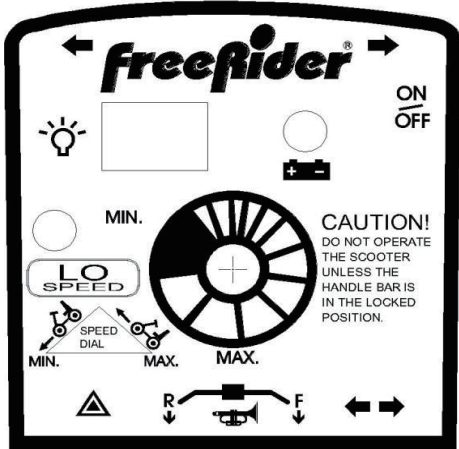

In order to avoid the damage of the wire of tail-light caused by pulling, please lift the rear shroud and carry it gently when you dismantle the scooter.

**WARNING**  
**EMERGENCY FREEWHEEL DEVICE**  
 NEVER SIT ON YOUR SCOOTER WITH THE FREEWHEEL DEVICE IN THE DISENGAGED POSITION. ALWAYS RE-ENGAGE THE EMERGENCY FREEWHEEL DEVICE AFTER USE. FAILURE TO COMPLY WITH THIS WARNING MAY RESULT IN INJURY.

**MAIN CIRCUIT BREAKER**  
**ON ↔ OFF**



<b>FreeRider</b> CORP.	SERIAL NO:	CE
MADE IN TAIWAN		
BRAND NAME: <b>FreeRider</b>	MAX.USER WEIGHT:	KG
TYPE:		





## LEARNING TO GET ABOUT

### 1. Basic Driving:

Make certain you are comfortably seated on your scooter and both armrests are down. Ensure that the "Speed Adjustment Dial" is turned to minimum for your first drive. When you have become more confident you can increase the setting to a higher speed. Push the right "Thumb Lever Control" as described earlier. You will very gently move forwards. Release the lever, and you will gently stop. Practice these two basic functions until you get used to them. Steering the Scooter is easy and logical by turning the handlebars in the direction you wish to maneuver.

### 2. Incline Control:

When you approach an incline, it is best to lean forward. This moves the center of gravity of your scooter towards the front of the scooter for improved stability. When going down an incline, keep your speed slow. This will keep you in a safely controlled descent. It is best to lean backwards; this moves the center of gravity of your Scooter towards the rear of the scooter for improved stability. If you wish to stop completely, release the control lever, and you will come to a gentle stop, avoid sudden stop or starts.

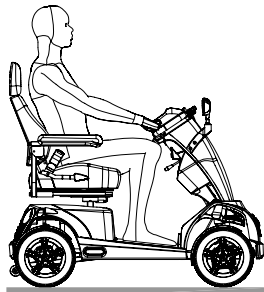

Normal driving position

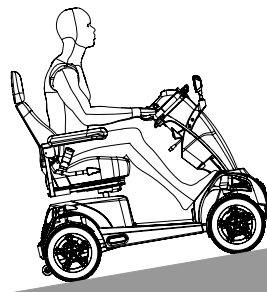

Increased Stability driving position

### 3. Control Over Stationary Obstacles

Stationary obstacle (steps, curbs etc.) must be avoided where possible. Proceed with extreme caution when driving near raise surfaces, unprotected ledges and / or drop offs such as curbs, porches, stairs etc.

Most new pavements have wheelchair access ramps at intersections, use these at all times. Plan your route where possible to avoid poor and uneven surfaces. **DO NOT** attempt to ride up or down curbs as you may ground your scooter and damage it's construction.

CURB

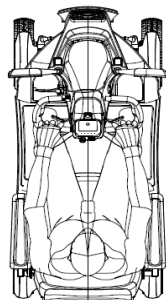

Correct

CURB



Incorrect

#### 4. Control Over Grass & Gravel ETC.

Care must be taken when attempting to drive over soft surfaces such as those found in parks etc. The surface may look level, but this can be deceiving and hidden dangers may make your scooter become unstable or grounded. Avoid unkempt grass, loose deep gravel or sand; **DO NOT** exceed the capabilities of your scooter. **ALWAYS** have an attendant to assist you in circumstances where you are not certain of the terrain. **ALWAYS** anticipate and think safety.



**Caution:** Because of the power of your scooter, you will be able to climb inclines. But the maximum safe gradient limit is 6 degrees. The reason for this is to ensure good stability.

**ALWAYS** have the anti-tipping wheels fitted to your scooter. They are an important part of your scooters design and reduce the likely hood of backward tipping.

**ALWAYS** avoid where possible turning on slopes or climbing curbstones. **ALWAYS** make certain that your scooter is in full working order and your batteries are fully charged before attempting to drive. Never attempt to drive beyond the design capability of your scooter. Observe weather conditions. Tires can slip on wet or icy surfaces.

#### **DO NOT DRIVE THROUGH DEEP WATER OR LEAVE YOUR SCOOTER EXPOSED TO HEAVY RAIN**

i.e. During or after a thunderstorm.

**DO NOT** attempt to turn when negotiating an incline, only turn when all wheels are fully on or off the incline; failure to observe this warning could result in the machine becoming unstable and toppling over. **ALWAYS** lean forward when ascending an incline and backwards when descending an incline. This will enable you to maintain good stability and will eliminate any chance of a rear or forward upset.

*PLEASE Note: The rear stability of your scooter is dependent on a number of factors which you should consider before attempting to climb an incline or other obstacle:*

- (a) Your height;
- (b) The height of your seat;
- (c) Your weight;
- (d) The angle of the incline you are attempting to climb.

All of these factors can affect the rear stability of your scooter. If you are unsure of your capability to climb an obstacle, then try another route.

**Always think "safety first".**



## CARE & MAINTENANCE

Your scooter, like any other electro-mechanical machine, will benefit from regular servicing by your dealer. You too, can help keep your scooter in good condition by following a simple guide to home maintenance.

*Note: Only competent people should carry out service work.*

### SEAT UPHOLSTERY

A damp cloth and a little soapy water will keep your seat, backrest and arms looking smart. **DO NOT** use abrasive cleaners as this will damage the coating. Upholstery can be damaged by chemical cleaners.

The coating material can also degrade over a period of time due to contamination by natural oils in the hair and skin or from medicated power products. Ultra-violet light can also reduce the life of the upholstery coating material. This is a normal ageing process and cannot be guaranteed.

### BODYWORK

The painted bodywork on your scooter can be lightly washed with clean soapy water. **DO NOT** use abrasive cleaners or strong detergents. This could fade the color; shampoo for automobile works well. Remove salt contact as this is very corrosive to bright metal parts.



**Caution: DO NOT** hose down your scooter with a powerful cleaner. Water could be forced into the electronics and cause permanent damage.

On the painted finish, be cautious not to wash with a dirty cloth as this could scratch the paint finish. Auto polish can be used to keep the paintwork and bright chrome parts in pristine condition.

The metal framework of your scooter should be cleaned twice a year and any paintwork damaged should be treated to prevent further attack from the elements. Wash regularly if contact is made with road or sea salt, this is very corrosive.

**DO NOT** store your scooter in damp conditions. This may affect the electronics if left for very long periods of time. Moisture, if left unattended can cause deterioration on metal work, protect with proprietary cleaners.

### ELECTRONICS

Servicing of the drive electronics and charger should only be carried out by your local service dealer. These units are sealed and should not be opened.

### BROKEN SEALS WILL INVALIDATE YOUR GUARANTEE.

**DO NOT** operate your scooter in exceptional weather conditions, ie. very heavy rain or wind. Cover your machine up if it is to be left unattended and outside for a long period of time.

**DO NOT** drive through deep water with your scooter. This could damage the electronic speed controller. Sea and road salts are very corrosive and should be neutralized quickly.

### MOTOR

The motor on your scooter is fitted with four long-life brushes. The brushes should be inspected for wear every 12 months or more frequently if you use your scooter daily for long periods. The brushes should be changed when they have worn down to approximately 8 mm in length.

## DRIVE TRANSMISSION LUBRICATION

This unit is factory filled and will not normally need additional lubrication.

*Note: Your scooter transmission is filled with a special lubricant. **DO NOT** attempt to force grease into the transmission as this will contaminate the original lubrication and will invalidate your guarantee.*



**Caution:** Take care when handling the transmission, keep well away from clothing. It is normal to find a light film of lubrication around this part.

## MOTOR BRAKES

*Safety Note: For your own safety, we recommend that you check the function of your scooter brakes prior to a journey.*

Motor Brake: If the motor brake is functioning correctly and the drive is engaged you will not be able to push your machine when it is switched off. Or switched on with the speed control lever in the "zero speed", central position.



**Warning:** If your machine can be pushed as described above, the motor brake could be faulty. Please **DO NOT** use, contact your local distributor.

*Note: Check the "Freewheeling Your Scooter" section of this manual.*

## DRIVING BRAKE



**Warning:** When you drive your scooter and you let go of the speed control lever your scooter should reduce speed very quickly. If you notice a change in the normal slowing/braking condition of your scooter and it does not slow down quickly, please do not use your machine, and contact your dealer.

## MANUAL EMERGENCY BRAKE

The manually operated "Emergency Brake" is designed to be operated only in the case of mechanical or electronic failure to the motor and driving brakes, previously mentioned.



**Caution:** On no account operate this brake in conjunction with the electronic motor brakes. Failure to observe this instruction may cause damage or premature wear to the motor and transmission system.

The manual brake system can be adjusted for wear to the braking material by adjusting the operating cable length adjustment nut.



**Warning:** Brake adjustment should only be carried out by a competent engineer, failure to observe this warning could put the brakes in an unbalanced state and may cause damage to you or your scooter.

## TYRES

Check the condition of your tyres regularly. Look for signs of wear, cuts and foreign objects lodged in the tread. Maintain the tyre pressures at all times; failure to comply with this can lead to poor performance of your machine and could make your machine unsafe and/or unstable. Tyres should be replaced when the tread is worn to 0.5mm.



**Warning:** Your scooter is designed with "split" wheel rims. **DO NOT** remove wheel bolts with the wheel inflated. Maintain pneumatic tyres at the recommended tyre pressure found in this manual under "Technical Specifications" Failure to observe this warning may result in personal injury.

### TYRE SERVICING-REAR WHEEL

To remove the wheel for service follow these instructions:

1. Place your scooter on a suitable work stand.
2. Deflate tyre as necessary.
3. With the aid of a 19mm spanner remove the centre nut from the wheel axle slide the wheel from the axle noting any spacers and bearings.
4. With the aid of two 13mm spanners (not supplied) remove the 8mm nuts and bolts from the wheel rim and centre hub. (Have you deflated the tyre?)
5. Part the inner and outer wheel rims from the axle hub and tyre side wall.



To reassemble the wheel following the installation of the replacement tyre or tube follow the above procedure in reverse order noting the following points:

1. Make certain you have securely tightened the two split wheel rims to the centre hub with the original nuts and bolts.
2. Make certain your tyre is correctly inflated to the recommended pressure.
3. Make certain the hub bearings and any spacer washers or bushes are correctly located.
4. Tighten the special "nyloc" locking centre nut.

*Note: If the plastic locking ring on the nut is damaged the nut should be replaced.*

*Note: The rear wheel hubs are located to the drive axle by a steel key. If the hubs need removing for service, you will first need to remove the hub centre nut with a 19mm spanner. Please note the hub fits firmly onto the drive axle, removal of the hub will be aided with the use of a suitable "puller" tool.*



**Warning:** Please note the rims of your wheel are a split rim system, **DO NOT** dismantle the wheel from the hub without first letting air out of the tyre.

### TYRE PRESSURES

The scooter wheels are pneumatic and their pressure needs to be maintained at Front 30psi (2.1 bar) Rear 35psi (2.5 bar).



**Warning:** Pressures exceeding those recommended will result in an uncomfortable ride. Underinflation will result in poor battery and motor performance. **DO NOT** inflate to the maximum pressures marked on the side wall of the tyre, this could damage the tyre or wheel rim. These pressures are the tyre manufacturer's maximum pressures and are not suitable for your scooter.

### BATTERIES

Keep your batteries well charged. Keep batteries clean and in a dry frost-proof place. Keep battery terminals tight. Your local dealer will be able to test your batteries for their state of service.

*Note: A charge may be made for this service.*

## BATTERIES

Keep your batteries well charged. Keep batteries clean and in a dry frost-proof place. Keep battery terminals tight. Your local dealer will be able to test your batteries for their state of service.



**Caution:** It is not possible to predict the life expectancy of your batteries. This is mainly due to the different workloads a battery can be subjected to.

Some users will use their scooter every day and for long periods of time. Their batteries will receive a near total discharge, and the life of the batteries will be short (12 months or less some cases). Other users will use their machines less frequently, putting their batteries through a less demanding discharge lifestyle. These batteries will probably have a longer life in excess of 12 months. This can only be a general guide and one cannot be more specific, due to other factors such as; motor loads, tyre pressures, general service factors, working conditions, periods of non-use and abuse etc.

When you need to purchase batteries, **ALWAYS** insist on the model fitted as original equipment to your scooter. **DO NOT** use less expensive car starter batteries. If in doubt, consult your local dealer.



**Warning:** Correct disposal of exhausted batteries is advised.

*Please note: The charger supplied with your scooter is specifically designed for sealed type batteries and may not work correctly with other battery designs.*

## LUBRICATION

The scooter has been designed with low maintenance in mind. Wheel bearings and steering bearings are sealed for life. The following points will need checking/lubricating at the following service intervals:

## RECOMMENDED SERVICE INTERVALS

DAILY Check the following:

1. Operation of motor brake.
2. Operation of driving brake.
3. Operation of manual emergency brake.
4. Operation of seat lock.
5. Tyre condition.
6. Batteries are fully charged.
7. Operation of driving lights and turning indicators.



**Caution:** **ONLY** drive your Freerider Westminster if it is in full working order.

WEEKLY Check the following and adjust as necessary:

1. Arm rest tightening knobs.
2. Tyre pressures.
3. Battery fastening strap.
4. Allow battery charger to go through a full recharge cycle until the green light is illuminated.

5. Clean paintwork with auto shampoo. **DO NOT** use a high pressure hose. Wax painted and bright metal parts.

SIX MONTHS Check and adjust as necessary:

1. Tyre wear, replace as necessary (minimum tread 0.5mm).
2. All fasteners and fittings for sound function
3. Tension of handle bar lock and hinge bolt
4. Battery connections
5. Inspect all electrical plugs and sockets for damage and good contact and fit.

Lubricate the following:

1. Wig-wag accelerator lever pivot point.
2. Spray metal parts with moisture repellent (WD40).
3. Seat lock lever pivot bolt.
4. Seat arm hinges.
5. Inspect, lubricate and adjust upper handle bar steering bearings.

ANNUALLY Check the following and adjust as necessary:

1. Motor carbon brush wear (minimum brush length 8mm).
2. Front wheel bearings for wear.
3. Chassis for sound welds.
4. Rear Drive wheel hub key.
5. All wheel bolts.
6. Drive axle securing nuts.
7. Motor mounting bolts.
8. Magnetic motor brake disc and function.
9. Manual brake shoe lining wear.
10. Main control box electrical connections.
11. Main wiring loom for damage.
12. All steering components.
13. Clean chassis and repaint any exposed parts.
14. Lubricate on/off power key barrel with light oil.
15. Replace any damaged axle seals.
16. Cycle test charger for full operation function.
17. Cycle test batteries for operating capacity (This test can be performed by your local dealer).



## LUBRICATION

Use a general purpose light lubricating oil on moving parts. All wheel bearings are factory sealed and should not normally need lubricating.

Your drive axle is factory filled with a special lubricant and will not normally need replacing.



**Caution: DO NOT** mix other lubricants with this factory fitted drive axle lubricant. Failure to observe this caution will invalidate your guarantee.

*Please note: These service intervals are a guide, more frequent use of your scooter may require adjustment to these suggested intervals.*

## RECOMMENDED AREAS FOR ADJUSTMENT

### STEERING COLUMN ADJUSTMENT

The steering column locking system works on a "cam" principle to lock the column in the desired driving position

If you notice the column is not firmly held when the black cam operating lever is fully down, follow this procedure to re-adjust the "cam" tension:

1. Push steering column forward as far as it will go with the locking lever released, i.e. pushed upwards. Support steering column.
2. With a 10mm spanner (not supplied) loosen the locking nut positioned on the opposite side to the black locking lever.
3. Next to the locking nut is a chrome threaded "clamping nut" this has a slightly tapered shape. Turn this clamping nut clockwise approximately a quarter of a turn.
4. Push the "black" clamping lever down and test that the tiller is tightly held in place; adjust
5. "clamp nut" until correct tension is achieved on clamp plates.  
Tighten locknut with 10mm spanner.

**DO NOT** drive your scooter with the steering handlebars unlocked or poorly adjusted.







## BATTERIES & BATTERY CHARGING

### BATTERY INSTALLATION

Your scooter is equipped with two maintenance free 12 volt batteries. The batteries are linked together by wiring cables to supply the electronic system with 24 volts of power.



**Warning:** It is imperative that the two batteries are connected correctly to prevent a short circuit between the two batteries.

When first installing the batteries follow these assembly instructions:

1. Connect the red wire of the battery cable to the + inal of the battery, with then nut and washer provided.
2. Connect the black wire of the battery cable to the negative terminal of the battery, with the nut and washer provided.
3. Repeat this procedure on the second battery making certain the red/black terminal covers are secured over each terminal.
4. Position each battery onto the scooter frame.



**Caution:** Batteries are heavy you may require assistance.

5. Secure the two batteries into position with the clamp bracket, "J" bolt and wing nut supplied.

*Note: The "J" bolt hooks into an 8mm hole situated in the seat post support bracket.*

6. Connect the two grey plugs of the batteries grey sockets of the wiring circuit.

7. Switch on your Scooter, the battery meter will now illuminate to show the state of charge in the batteries and your scooter is ready to drive.

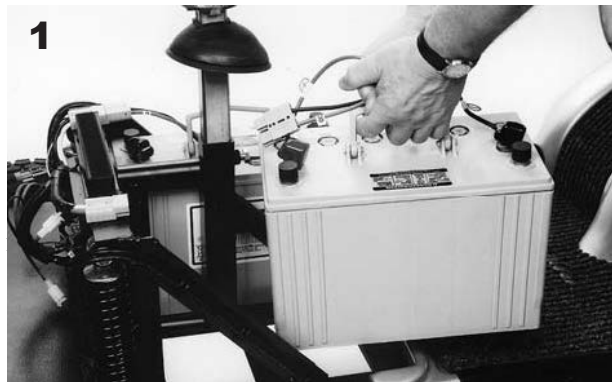

8. Switch off your scooter, fit the battery cover and seat.

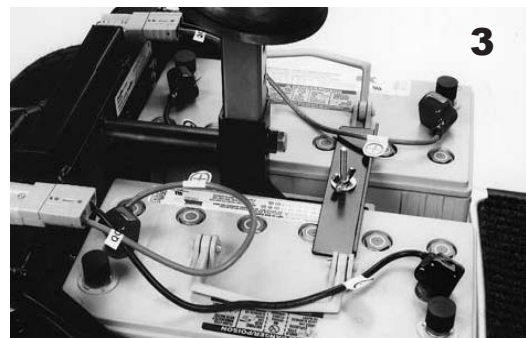

## BATTERY CONNECTIONS



**Warning:** Batteries are heavy, **ALWAYS** handle with two hands. You may require assistance. **DO NOT** allow metal tools to touch both battery terminals together, this will cause an electrical short and may damage the battery and injure you. **ALWAYS** cover the battery terminals with the red/black covers.

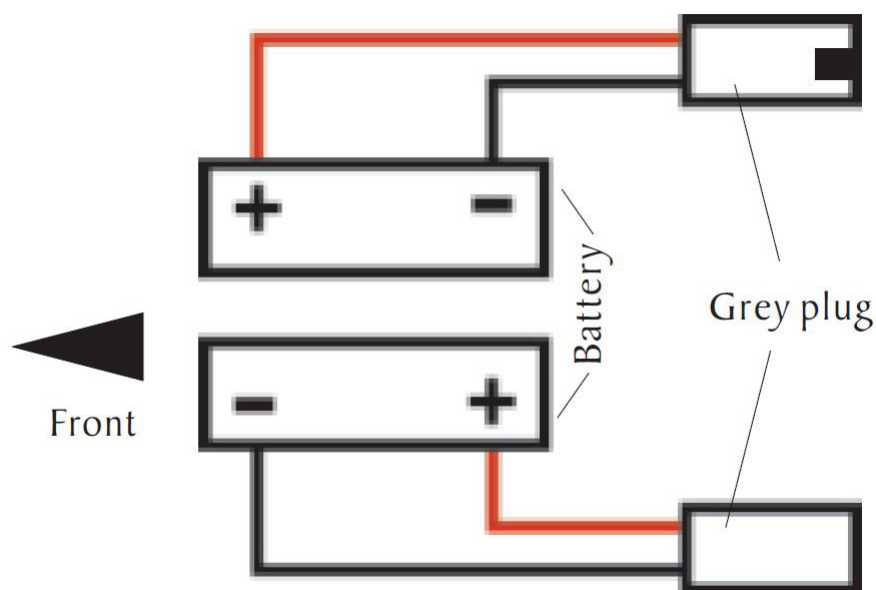

## BATTERY CHARGING

You have a lot of power for a scooter. Keeping it working to its maximum potential means that its two batteries must be maintained with full power. Nightly recharging, after use, will help you to give them a longer life and will ensure you are always ready to go when you are.

## BATTERIES

Your scooter is fitted with two sealed maintenance-free Batteries, especially designed for motive traction use. This means that you do not have to worry about topping up the cells.



**Warning:** **DO NOT** attempt to remove the safety valves situated in the top of the battery. Failure to observe this warning will invalidate your battery guarantee.

Your batteries are virtually maintenance-free because the electrolyte is immobilized in a special form and therefore will not leak out, even if the battery is accidentally overturned.

Because your batteries are sealed they are more likely to be accepted for carriage on aircraft. Please consult your carrier prior to departure, as they will need advance warning that you wish them to carry batteries.

*Please note: Each carrier reserves the right not to carry what may be termed "HAZARDOUS CARGO". The dealer cannot be held responsible for their final decision.*

## BATTERY CHARGER

The battery charger supplied, is special to your scooter and it may not be suitable for any other powered mobility product. **ONLY** use the charger supplied with your scooter; other makes of charger may permanently damage your batteries and would invalidate the guarantee.

## **CHARGING THE BATTERIES**

Please refer to the battery charger instruction attached along with the battery charger.

### **YOUR GUIDE TO SAFE AND LASTING BATTERIES**

1. For longest life, your batteries should always be re-charged after use. Preferably over night.
2. If your scooter is not used for a period of time, a refreshing charge should be given every month. Never leave your batteries in a discharged condition. This is particularly important with sealed batteries as fitted to your scooter. If your batteries fall below a total terminal voltage of 12 volts, the charger supplied with your scooter will not operate. Please consult your local dealer.
3. If your scooter has been stored away for some time, re-charge your batteries before re-using it.
4. Every month, check the connections on the batteries, making sure they are tight and clean.
5. Batteries carry a limited guarantee from the original manufacturer which is subject to a stringent wear and tear clause. Any battery faults due to a defect in the original manufacture will normally become obvious within the first two months. Any gradual deterioration in performance after this period is normally associated with fair wear and tear, mis-use or accidental damage and, as such, is not covered by the manufacturer's warranty. (This does not affect your statutory rights).

Note: If one battery becomes faulty during the guarantee period that battery from the pair will be replaced.

### **FREQUENTLY ASKED QUESTIONS**

Why do my batteries require recharging?

Batteries are the fuel tank for your scooter. They provide the vital energy to power your vehicle. When you ride your scooter, the drive motor consumes the energy stored in the batteries. The battery's energy is gradually reduced over the period of driving time and will need to be replaced before you can use your scooter again. Similar to the situation with a motor car, in that you need to replenish the fuel as it is used up as energy, likewise with your scooter, you need to replace the used battery energy by re-charging the discharged battery cells.

How does my Charger work?

Your battery charger is an intelligent automatic charging instrument. Your charger's robust framework contains a number of quality components; namely a transformer, rectifier and complex control circuitry. The charger receives the 100~240V domestic electricity supply via a standard 3-pin wall plug and reduces this voltage down to 24 volts via a transformer. At the same time it rectifies the A.C., alternating domestic current into D.C., direct current. This matches exactly, the voltage characteristics stored by your scooter's batteries.

Your charger automatically controls the re-charge cycle from the moment that you switch it on to the moment the green light on the face of your Charger illuminates.

When your battery's voltage is very low, the charger will work extremely hard to replenish the spent energy. As the battery voltage approaches 90% of the full charge capacity, the charger reduces its output for the final stage of the recharge cycle. The time taken from switch-on to the end of the bulk charging will vary, depending on the amount that the batteries have been used, or in time their age. At this point a timer is automatically started, to regulate the final stage of the charging cycle, this set time ensures maximum capacity and battery life.

The length of time to re-charge your batteries will vary from 6 up to 12 hours. This variation in time is due to the following factors:

1. Depth of discharge-The amount of energy you have removed from your batteries when driving your scooter.
2. Battery age-This is due to the changes in their internal electrical resistance.

Where can I re-charge my batteries?

In most safe domestic environments, i.e. your house, garage or shed. **DO NOT** expose to rain or spray - for indoor use **ONLY**.

Later on in this information, there is reference to the way temperature variations can affect the performance of your vehicle. When charging your batteries where reasonably practicable, ensure that the battery charger is close to the vehicle being charged so that the temperature of the battery charger and batteries are almost compatible.

For example, a scooter may be outside whilst the battery charger is inside. It is possible in this situation that the battery charger will sense the inside temperature, where as the batteries on the scooter will be at the outside temperature, resulting in an undercharged situation. This situation must be avoided.

How often must one re-charge my batteries?

Many factors come into play when deciding how often to charge your batteries. You may use your scooter all day on a daily basis or you may not use it for weeks at a time. Other factors such as driver and baggage weight, smooth or rough terrain, flat areas or inclines and speed must all be considered.

With these variables you should concern yourself with two questions:

HOW OFTEN should I charge and for HOW LONG? The Charger is designed so that it is impossible to overcharge your batteries. If you follow the guidelines below, your batteries will provide safe and reliable operation.

1. If you use your vehicle during the day. put it on charge as soon as you have finished using it. The Charger is fully automatic so it will not overcharge your batteries. Your vehicle will be ready each morning to give you a full days service. It is recommended that you charge your batteries after daily use until the green 'Charge Complete' light illuminates.
2. If you use your vehicle infrequently (once a week or less) you should charge it at least once per week until the green "Charge Complete" light illuminates. Remember: Keep your batteries fully charged and avoid deeply discharging them.
3. Storing batteries: Batteries should **ALWAYS** be stored fully charged. Check once a month and recharge fully if needed. Sealed batteries can hold their charge for approx. 6 months. **ALWAYS** disconnect battery leads. If they are left connected on the scooter, remember key switches, meters, and electronic circuits can drain the batteries rapidly. It is advisable to disconnect the batteries for prolonged storage. Store in a warm, dry room. **DO NOT** allow to freeze, if frozen, fully thaw in a warm room prior to recharging or you may damage your batteries.

**How can I ensure maximum battery life?**

Simply put, a fully charged battery is a happy battery! A fully charged battery will provide reliable performance and extended battery life, so keep your batteries fully charged whenever possible. Remember batteries are expensive to replace, good maintenance will save you an unnecessary expense!

## Handling your batteries

Extra care must be taken when handling batteries, if you decide to dismantle your vehicle for transportation etc. Dropped batteries, even from a very small height, can lead to damage of the internal components, causing premature cell failure. Your batteries are sealed and **DO NOT** require maintenance. **DO NOT** force open the valves in the battery top.



**Warning:** Batteries are heavy, you may need assistance when lifting.



**Caution:** Used batteries must not be disposed of by means of a domestic refuse disposal unit (dustbin) etc. Please contact your dealer to dispose of used batteries. Please note, he may charge for this service.

## BATTERY WARRANTIES

The batteries fitted to your scooter are guaranteed against a manufacturing or material defect for 12 months. Any battery faults due to a defect in manufacture or materials will be obvious within a few weeks of use. Your batteries are not guaranteed to perform to full capacity for 12 months. This will, of course be dependent on the actual use of the vehicle and how often the batteries are cycled i.e. discharged and charged.

Gradual deterioration in performance and reduction in range is normal and associated with fair wear-and-tear, misuse or accidental damage. Under these circumstances, the warranty will not apply. It is a fact that some users due to their hectic lifestyle, weight or operating conditions, may wear their batteries out during the original battery manufacturer's guarantee period due to extensive use of their scooter. This is termed "Cycle Life". Batteries have a defined number of discharge cycles they can make i.e. the more times you use your scooter the more cycles your battery will make-the shorter their life span.

If you take time to run-in your batteries properly, it will be worth it. Remember: how long your batteries will provide service is quite often a reflection of the care they receive. This is how to run-in your new batteries:

1. Fully recharge any new batteries prior to your initial use. This will bring your battery up to about 88% performance.
2. Ride your scooter around the local area. **DO NOT** venture too far away until you become accustomed to the controls and feel of the scooter. This will gently run-in your batteries.
3. Give your batteries another full charge and run the vehicle again. The batteries will now perform to over 90% of their full potential.
4. After 15 to 20 charging cycles, the batteries will top off at 100% charge and last for an extended period due to your patience and care in the first few days of operation.

How can I get the maximum operating time per charge?

Rarely do we have an ideal driving situation such as a smooth, flat, hard terrain with no wind or curves and warm temperatures. More often, we are presented with hills, uneven and loosely packed surfaces, curves, wind, cold and heavy loads. All of these factors will affect the distance or running time per battery charge.

Here are a few suggestions for obtaining the maximum range per charge:

1. **ALWAYS** charge your batteries fully prior to your trip. It is a good idea to keep your Charger connected when the "Charge Complete" (green) light is illuminated in the "Top- Up" mode.

2. Maintain relevant tyre-pressures as stated in the "Technical Specifications" of this User's Instruction Manual.
3. Plan your trip in advance to avoid inclines, kerbs and soft surfaces.
4. Limit your baggage weight to essential items.
5. Try to maintain an even speed to avoid stop and start driving.
6. Ensure recommended routine servicing of the vehicle's components, i.e. motors, brakes, electrical connections etc., is carried out as instructed in this User's Instruction Manual.



**Warning:** When working or disposing of your batteries.

1. **ALWAYS** make certain the terminals of your batteries are covered with the red/black terminal protectors. **DO NOT** allow metal objects to short out the terminals, your battery could explode causing you injury.
2. **DO NOT** allow your batteries to freeze. If frozen allow them to naturally thaw out before charging, failure to observe this warning may damage the batteries.
3. If you need to replace your batteries, contact your local dealer. Only batteries supplied as original equipment on your machine will give you the best performance. When charging batteries make certain the positive and negative terminals are correctly assembled. Failure to observe this warning may cause an explosion, short circuit or fire.
4. **ALWAYS** handle batteries carefully, they are heavy, it may require two people for lifting. Wear protective gloves and glasses when handling.
5. Dispose of worn out batteries carefully, contact your local waste disposal authority.

#### CHARGER MAINS PLUG

Your charger's main input cord is already fitted with a moulded plug incorporating a fuse, the value of which is indicated on the pin face of the plug. Should the fuse need to be replaced, an ASTA approved BS1362 fuse must be used of the same rating. If the plug supplied is not suitable for your socket outlet, it should be cut off and destroyed. The end of the flexible cord should be suitably prepared and the correct plug fitted. If any other type of plug is used a 5amp fuse must be fitted either in the plug, adaptor or at the distribution board.



**Warning:** A plug with bared flexible cord is hazardous if engaged in a live socket outlet.

#### PLUG WIRING INSTRUCTIONS

Important: The wires in the mains lead are coloured in accordance with the following code: Blue-neutral, Brown-live. As these colours may not correspond with the coloured markings identifying the terminals in your plug, proceed as follows: The wire which is coloured Blue must be connected to the terminal in the plug which is marked with the letter N or coloured Blue or Black. The wire coloured Brown must be connected to the terminal which is marked with the letter L or coloured Brown or Red.



**Warning:** **DO NOT** connect either wire to the earth terminal which is marked with the letter E, by the earth symbol or coloured green or green/yellow.



**Caution:** Fittings marked are double insulated and do not need to be earthed. If in doubt or difficulty is experienced, consult a qualified electrician.



## BASIC FAULT FINDING

### If your scooter will not start:

(1) Check that the power key switch is turned "on". If it is, the battery condition indicator meter will be operating. If the green status light on your console is flashing once per second, charge your batteries.

If the battery condition meter and the green status light fail to operate when the key switch is in the "on" position, check the following:

- (2) Make sure the battery charger is not plugged into the tiller charge socket, this will prevent the scooter from driving.
- (3) Check both battery connectors. Check battery terminal condition.
- (4) Check the circuit breaker.

If your scooter stops for no apparent reason, it is probably due to the circuit breaker disconnecting from the speed control electronic box.

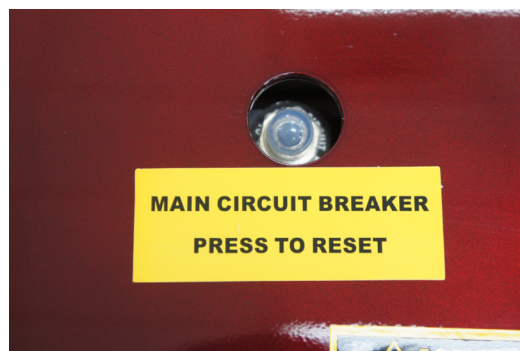

On rare occasions, a temporary overload on the electric circuit can occur – for instance when climbing a steep incline. If this happens, reset the circuit breaker, wait for two minutes to allow the temperature activated switch to cool down. Locate the plunger on the circuit breaker through the access hole. Place a finger onto the circuit breaker and press down on the plunger until it remains down. You are now ready to drive again. If the circuit breaker trips up again wait for 5 minutes and try again.

### 1.Fault Diagnosis:

Faults with the main speed controller are rare. Most faults on powered vehicles are associated with wiring or misconnections due to poor maintenance or incorrect installation of connectors when assembling the scooter after transportation in a car.

If your scooter should fail to operate, you will be assisted in diagnosis and locating the area of the fault by observing the number of flashes emitted from the "green" status light on your control console.

## 2.Charging Circuit Fuse:

One fuse protects your scooter charging circuit from receiving an overload of electrical current. The fuse used in the scooter is the same type which is found on automobiles. In the unlikely event that a fuse should "blow" and needs replacing.

Use only a fuse of a 10 amp rating. Please note this size of fuse has been selected to give your scooter the best protection without premature fusing.



**Warning: DO NOT** use fuses with a higher rating than 10 amps as this may cause permanent failure to the wiring and wiring connectors or personal injury. For access to a fuse remove the four screws located in the rear body cover, and then lift the cover.

Locate and lift the fuse block on its wire, lift up the fuse lid and withdraw the "red" fuse. Replace the blown fuse with recommended 10 amp (pink) fuse, close fuse lid and replace fuse block.

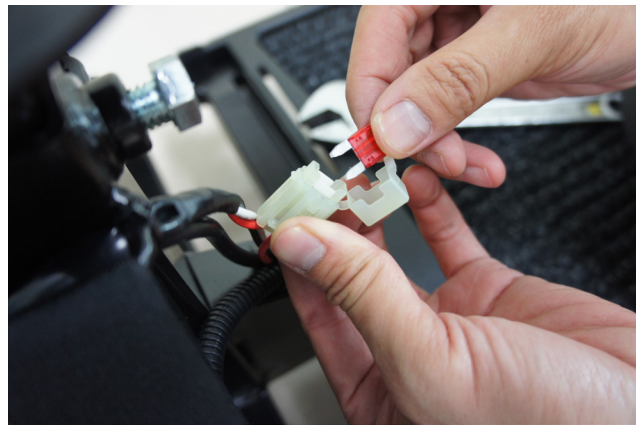

The scooter only uses a fuse of a 10 amp rating. Please note this size of fuse has been selected to give your scooter the best protection without premature fusing.

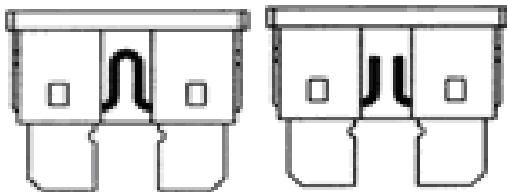



### 3.Status Fault Codes:

Flash	Description	Meaning
1	Battery Low	The batteries are running low. ●Recharge the batteries.
2	Low Battery Fault	The batteries have run out of charge. ●Recharge the batteries. ●Check the battery and associated connections and wiring.
<p><i>Note: The low battery fault flash code,described above, is a requirement of various safety standards. The scooter will output a visible and audible low battery warning if the battery voltage drops below 90% of its cut-off voltage.</i></p> <p><i>The warning will be two short flashes, and will take priority over all other flash codes in the system.</i></p>		
3	High Battery Fault	Battery voltage is too high. This may occur if overcharged &/or travelling down a long slope. ●If travelling down a slope, reduce your speed to minimise the amount of regenerative charging.
4	Current Limit Time-out	The motor has been exceeding its maximum current rating for too long. ●The scooter may have stalled. Turn the controller off, leave for a few minutes and turn back on again. ●The motor may be faulty. Check the motor and associated connections and wiring.
5	Park Brake Fault	Either a park brake release switch is active or the park brake is faulty. ●Check the park brake and associated connections and wiring. ●Ensure any associated switches are in their correct positions.
6	Throttle OONAPU (Out Of Neutral At Power Up)	Either a stop function is active or a charger inhibit or OONAPU condition has occurred. ●Release the Stop condition (seat raised etc.) ●Disconnect the battery charger ●Ensure the throttle is in neutral when turning the controller on. ●The throttle may require re-calibration.
7	Speed Pot Fault	The throttle, speed limit pot, their associated wiring may be faulty. ●Check the throttle and speed pot and associated connections and wiring.
8	Motor Voltage Fault	The motor or its associated wiring is faulty. ●Check the motor and associated connections and wiring.
9	Other Error	The controller may have an internal fault. ●Check all connections and wiring.



## TECHNICAL SPECIFICATION

<b>Model Number</b>	<b>FR510-GDX</b>
Overall Length* <sup>2</sup>	60 inches (152 cm)
Overall Width* <sup>2</sup>	29 inches (74 cm)
Total Weight with Batteries* <sup>1</sup>	377 lbs. (171.5 kg)
Total Weight Without Batteries	237 lbs. (107.5 kg)
Battery Weight 97Ah (Each)* <sup>4</sup>	70 lbs. (32 kg)
Turning Radius	24.8 inches (62.8 cm)
Speed (Maximum)* <sup>1</sup>	8 miles/hr (12.8 kph)
Range Per Charge* <sup>1</sup> * <sup>5</sup>	30 miles (48 km)
Ground Clearance	3.5 inches (8.8 cm)
Weight Capacity	500 lbs. (227 kg)
Standard Seating	Type: Foldable Weight (w/armrests): lbs. ( kg) Material: Grey Vinyl Dimensions: 19 inches (49 cm) depth 19 inches (48 cm) width
Drive System	Rear-wheel drive, sealed transaxle, 24 volt DC motor
Suspension	Front and rear shock absorber
Dual Braking System	Electronic, regenerative, and electromechanical
Tires	Type: PU solid Front and rear: inches ( cm)
Battery Requirements* <sup>3</sup>	Type: 12 volt, Size: 97 AH QTY: 2
Battery Charger	5-amp charger

- \*1. Varies with user weight, terrain type, battery amp-hour (AH), battery charge, battery condition and tire condition.  
These specifications can be subject to a variance of (+/- 10%).
- \*2. Due to manufacturing tolerances and continual product improvement, this specification can be subject to a variance of (+ or - 3%).
- \*3. Sealed lead acid required.
- \*4. Battery weight may vary based on manufacturer.
- \*5. Tested in accordance with ANSI/RESNA, WC Vol2, section 4 & ISO 7176-4 standards. Results derived from theoretical calculations based on battery specifications and drive system performance test conducted at maximum weight capacity.

*NOTE: All specifications subject to change without notice.*

#### **Features**

- **Delta tiller with wraparound handles**
- **Exclusive stylish, lightweight, non-scuffing, black, low-profile wheels**
- **Easy access tiller-mounted charger port**

#### **Options**

- **Combined Basket, Stick/Crutch holder**
- **Stick/Umbrella holder**
- **Oxygen tank holder**
- **Saddle (SEAT) bag**

The information contained herein is correct at the time of publication; we reserve the right to alter specifications without prior notice. Speed & range vary with user weight, terrain type, battery charge, battery condition and tire pressure. Due to manufacturing tolerances and continual product improvement, length, width, turning radius and ground clearance can be subject to variance of + or - 3 %.

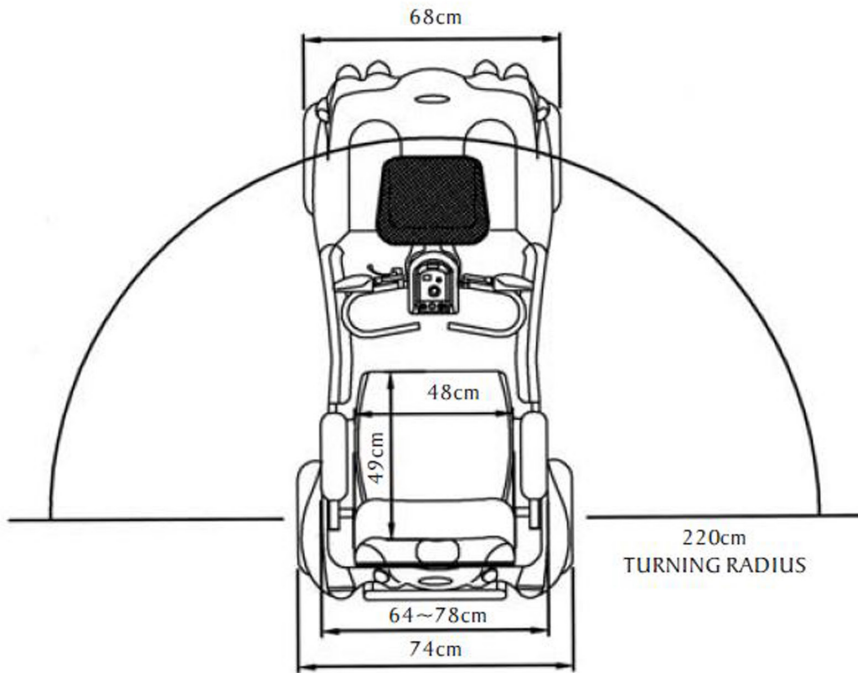
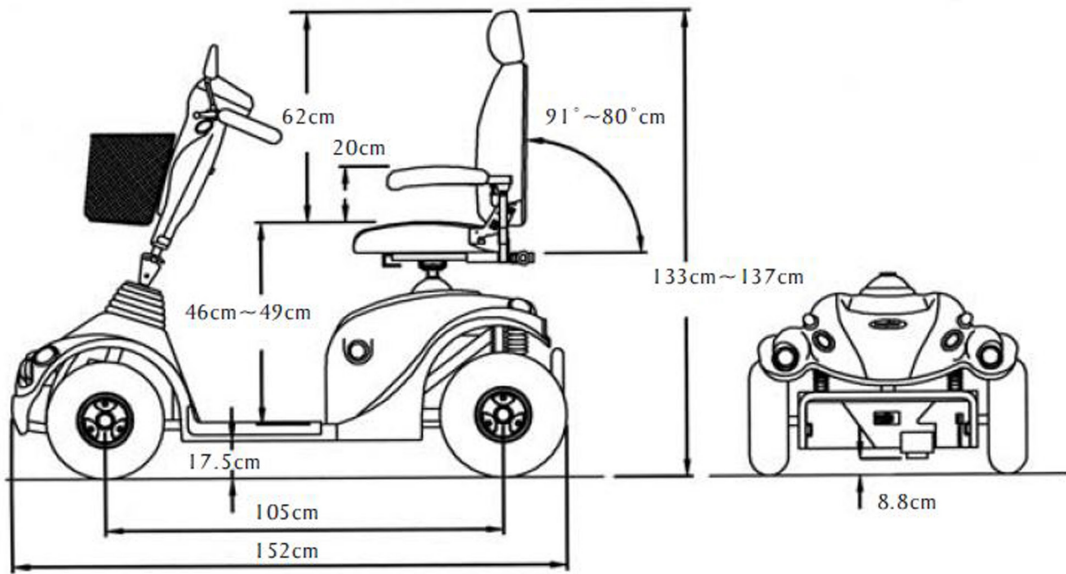



## CLASSIFICATION

Type 'C' (EN12184 : 1999) Class 3(The use of invalid carriages on the highway regulations 1988)  
Maximum safe climbing angle: 10 degree with 500lbs (227 kg) rider.



**Warning:** The safe climbing angle is measured with the seat in the highest position, and maximum weight capacity. The motor on your scooter is powerful and may be able to climb a steeper incline than the maximum safe climbing angle. Exceeding the safe climbing angle may put you at risk of injury. On no account must you attempt to climb an incline of more than 10 degrees. This will exceed the rear stability of your scooter.

**Range Per Charge:** up to 30 miles (48km)

*Note: Range varies with weight, terrain, temperature, battery condition etc. and is subject to manufacturing tolerances. Your battery will require a period of "breaking in" before they will reach their optimum capacity (up to 20 charge, discharge cycles can be expected) before full range is experienced. Refer to the battery charging section of this manual.*

**Tire Size:** Front 31 cm (12.5 inches); Rear 35 cm (14 inches)

**Batteries:** Lead Acid battery 50Ah

**Charger:** AC input.100-240 volt, 50/60Hz,  
DC output 24 volt. 5 Amp for Lead Acid battery  
Conforms to: EN60335-2-29 and EN12184  
EN12184:1999 (Clause 9.8)  
EN55022:2010, Class B  
IEC61000-4-2/ IEC61000-4-3

**EMI/RFI:** Field strength tested to 20V/m compliance.

**Electrical System:** 24 volt DC

**Drive System:** Rear wheel, direct drive via sealed drive axle.

**Brake:** Automatic dynamic regenerating braking system with spring activated magnetic solenoid parking brake. Free wheel facility. Manual brake to front wheels.

**Modular Design:** Easily dismantled into six basic pieces for convenient transporting.

**Adjustable Locking Tiller:** For driving comfort.

**Proportional Speed Control:** State of the art design for safe and smooth operation; incorporating 'Fault' diagnosis.

**Contoured Seat:** With sliding facility, adjustable for height, arm width and armrest angle. Swivels for easy access.

**Automatic Charger:** Charging point is on the handlebars.

# OPTIONAL ACCESSORIES

For information regarding these optional accessories please contact your local dealer.

 **Warning:** The rear basket and crutch /can holder will extend the dimensions of your scooter. Please allow for this when turning.

**DO NOT** overload carrying accessories as this will make your scooter less stable.

*Note: The maximum basket and storage box load 2 kg(4.5 lbs).*

 **Warning:** TThe all-weather canopy must not be used in high wind conditions.

*Note: The rear mounted storage items(\*)cannot be used when an All-weater Canopy is fitted.*



**/ ALL WEATHER CANOPY**

	<p><b>All weather canopy:</b> Protects you from winter showers, keeping you and your belongings dry. Zipped doors and integral rear storage compartment.</p>
---	--

**COMBINED BASKET, STICK/CRUTCH HOLDER\* / STICK/CRUTCH HOLDER\***

	<p><b>COMBINED BASKET, STICK/CRUTCH HOLDER*:</b> Combining the usefulness of the rear basket and the stick/crutch holder.</p> <p><b>STICK/CRUTCH HOLDER*:</b> Ideal way to carry your walking aids.</p>
---	---

**REAR BASKET\* / LOCKABLE STORAGE BOX\***

	<p><b>REAR BASKET*:</b> Provides easily accessible additional carrying capacity for shopping. Basket maximum load 2 kg (4.5 lbs).</p>
	<p><b>LOCKABLE STORAGE BOX*:</b> This smart storage box allows you to lock away your valuable items when leaving your scooter unsupervised. Maximum load 2 kg (4.5 lbs).</p>

 **Warning:** The rear basket and crutch/cane holder will extend the dimensions of your scooter. Please allow for this when turning. **DO NOT** overload carrying accessories as this will make your scooter less stable.

*Please note : Accessories illustrated are displayed on various models of your scooters.*



## GUARANTEE TERMS

Please keep a note of your serial number.

(This is located on the front frame tube, under the front chassis cover).



Your scooter is guaranteed for 12 months from the date of purchase against faults arising due to defects in manufacture or materials. This guarantee does not detract from, but is in addition to your legal rights. Parts replaced or repaired under the terms of this guarantee will be covered for the balance of the 12 months period.

This guarantee applies **ONLY** to parts supplied or approved by local dealer.

This guarantee is not transferable.

Note: Extended guarantee insurance can be arranged by your dealer. The dealer will be able to advise the extra cost for extended guarantee insurance.

### METAL WORK:

Metal components, such as the framework and bright metal parts require special attention and may deteriorate in certain conditions. Moisture and salt may corrode parts left unattended, proprietary auto cleaner polishes should be used to prevent long term damage. Failure to clean and protect these components may void your warranty.

### SPEED CONTROLLER:

Servicing of the speed controller or battery charger must **ONLY** be carried out by your local authorised distributor. Any attempt to open or dismantle these items render the guarantee void on that item.

### BATTERIES:

Batteries carry a limited 12 month guarantee from the original manufacturer which is subject to a stringent wear and tear clause. Any battery faults due to a defect in the original manufacture will normally become obvious within the first two months of use. Any gradual deterioration in the performance after this period is normal and associated with fair wear and tear, misuse or accidental damage and as such is not covered by the manufacturers warranty. (Batteries are guaranteed as single parts, **ONLY** the failed part is replaceable)



**Warning: DO NOT** attempt to open the battery vent plugs.



## SERVICE HISTORY

This section is designed to assist you in keeping a record of any service and repairs to your scooter. If you decide to sell or exchange your scooter in the future, this will prove most helpful to you. Your service dealer will also benefit from a documented record and this book should accompany the scooter when service or repair work is carried out. The service dealer will complete this section and return the book to you.

DETAILS OF WORK CARRIED OUT	DEALER STAMP
	DATE                      INITIALS

DETAILS OF WORK CARRIED OUT	DEALER STAMP
	DATE                      INITIALS

DETAILS OF WORK CARRIED OUT	DEALER STAMP
	DATE                      INITIALS

DETAILS OF WORK CARRIED OUT	DEALER STAMP
	DATE                      INITIALS



**YOUR LOCAL DEALER**  
(TO BE FILLED IN BY LOCAL DEALER)

**freerider®**

**FREERIDER CORP.**

Head Quarter and Kaohsiung Facility:  
No.22, Bengong 5th Rd., Gangshan Dist.,  
Kaohsiung City 820, Taiwan(R.O.C)  
Tel:886-7-6223093 Fax:886-7-6230373  
Email: sales@freerider.com.tw  
<http://www.freerider.com.tw>  
<http://www.luggie.com.tw>

2016.03.17 V1



PL90-1200